

Enclosure series aluDISPLAY

Type: ADI 240-W

Material-No.: 260.240.***, length (L) of profile variable

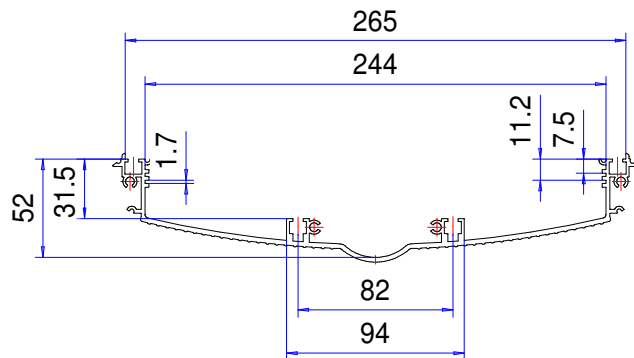
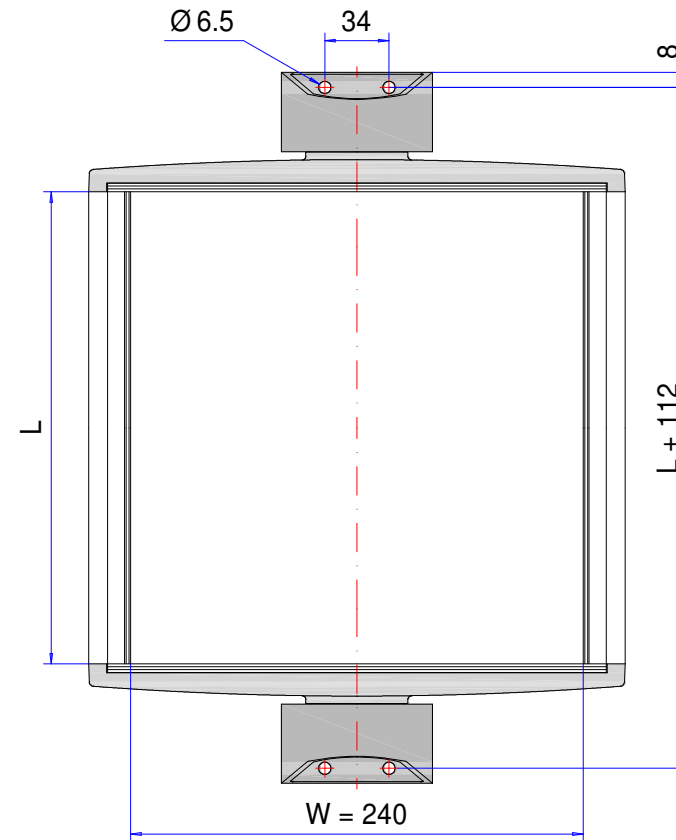
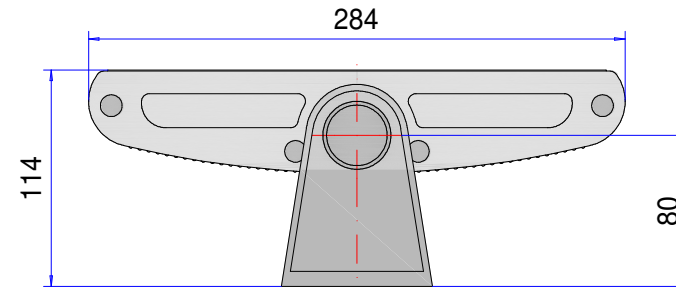

Enclosure material	Al Mg Si 12 (DIN 17615)		Ingress protection	IP54 EN 60529
Lid material	GD-Al Si 12 (DIN 1725)		Weight	Profile 5,928 kg/m + 0,720 kg
Lid screws	8x stainless steel 1.4567 (V2A), captive		Coating profile	Silver anodized
Gasket profile	1x Chloroprene (CR), light grey		Coating lid	Powder coating RAL 9005, black
Gasket lid	1x TPE moulded gasket, siliconefree, black		Tolerance	GTA 13/5 DIN 1688-4 (outside dimensions ±0,5mm)