

Enclosure series inoBOX

Type: IB 204

Material-No.: 245.204.000

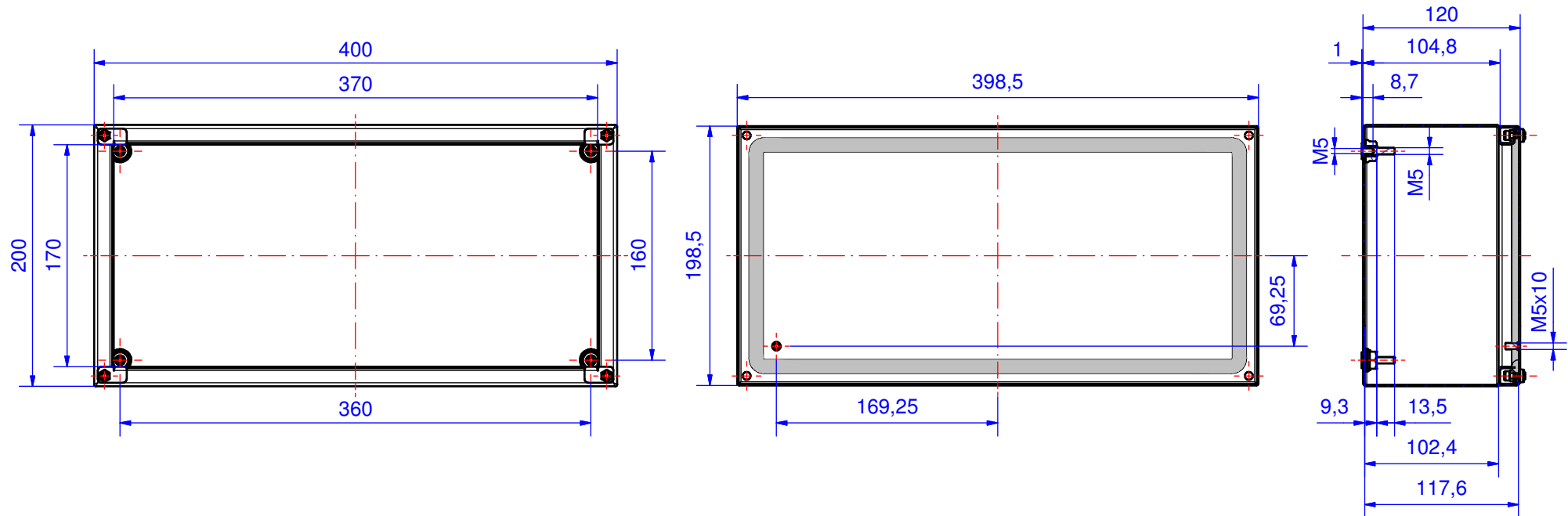

Enclosure material	V2A, 1.4301 (AISI 304)		Weight	3,5 kg
Lid screws	4x V2A, captive		Sheet thickness	1,2 mm
Gasket	Polyurethane, dosed gasket		Surface	Grinded, Scotch-Brite
Ingress protection	IP66 EN 60529		Tolerance	DIN ISO 2768-m DIN 6935