

Suspension-system Quadro 80

Type: Wall joint

Material-No.: 147.010.200

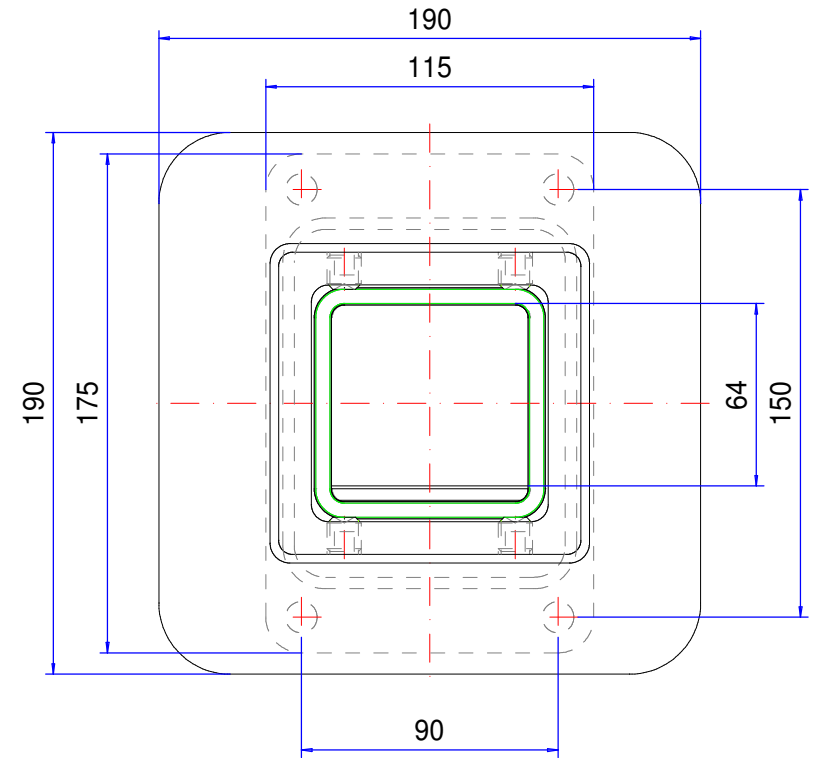
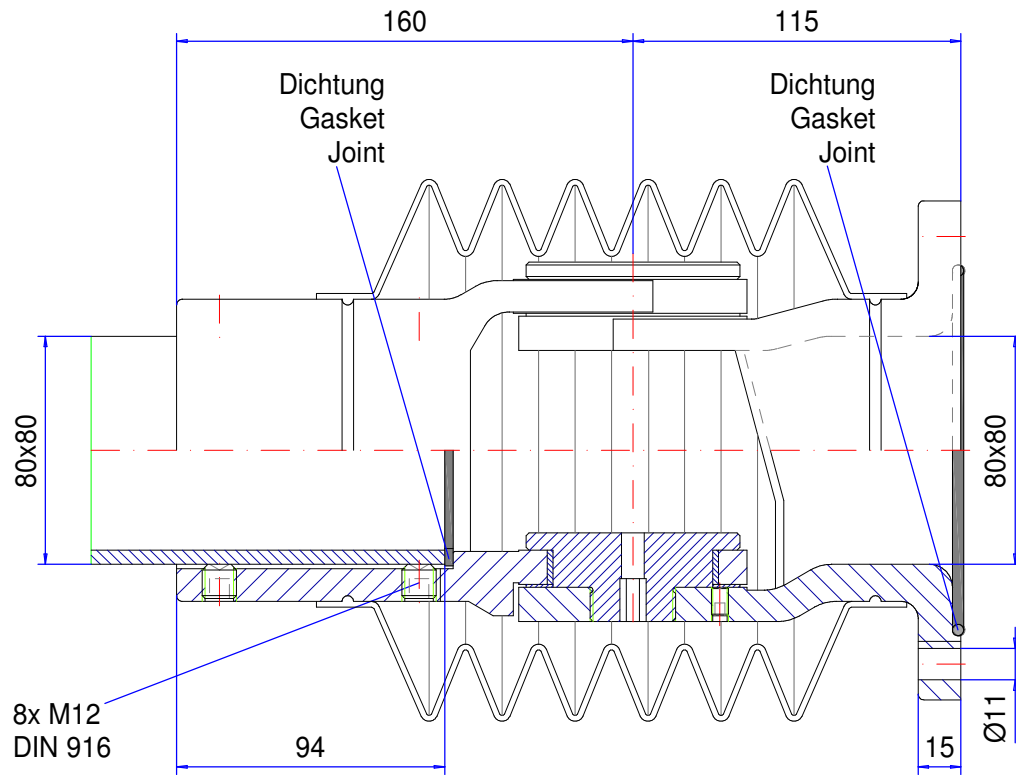

Material system elements	GGG-40 (DIN 1693)		Pivoting range	170°
Gasket	Chloroprene (CR), black		Weight	9,450 kg
Assembly screws	6x M12, galvanized steel		Coating	Powder coating RAL 7040, window grey
Ingress protection	IP54 EN 60529		Tolerance	GTA 14/5 DIN 1688-3 (outside dimensions ±0,8mm)